

HOW TO ASSEMBLE AND INSTALL KIRSCH ESTATE ULTRA DECORATIVE TRAVERSE ROD SETS

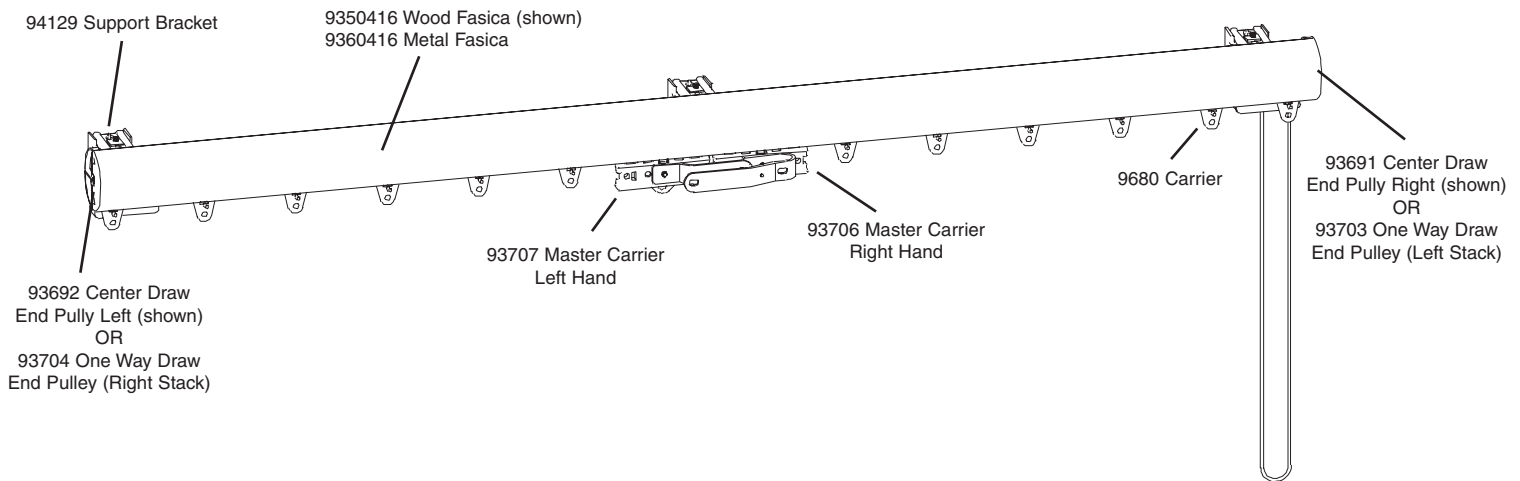

TWO-WAY DRAW

1. Determine overall width of set required, not including finials. Cut track, allowing for 5/8" for end pulley sets and fascia. Using 9997EU notching tool, notch both ends of track per figure 1.
2. Cut fascia to overall width. For the metal fascia, use 9994EU cutter.
3. If using rings, attach rings to master and standard carriers per figure 2.
4. Insert right and left-hand master carriers as shown in figure 3. Insert required number of standard carriers per figure 4.
5. Insert right and left hand center draw end pulleys per figures 5 & 6, attaching the carrier to the end pulley and end pulley to the track by a screw (not provided) #4 x 1/2" recommended.
6. String cord through pulleys and master carriers as shown in figure 7.
7. Attach wood or metal fascia to track per figure 8 or figure 9, respectively.

ONE-WAY DRAW

1. Determine overall width of set required, not including finials. Cut track, allowing for 5/8" for end pulley sets and fascia. Using 9997EU notching tool, notch stacking end of track per figure 1.
2. Cut fascia to overall width. For the metal fascia, use 9994EU cutter.
3. If using rings, attach rings to master and standard carriers per figure 2.
4. Insert right hand master carrier as shown in figure 3 for stacking on right. For stacking on left, use right hand master carrier with reversed master arm per figure 10. Insert required number of standard carriers per figure 4.
5. Attach a standard carrier to stack side end pulley. For stacking right, insert right center draw end pulley per figures 5 & 6, and insert one way draw end pulley left per figures 11 & 12. For stacking left, insert left center draw end pulley per figures 5 & 6, and insert one-way draw end pulley right per figures 11 & 12. Secure both pulleys to the track by a screw (not provided) #4 x 1/2" recommended.
6. String cord through pulleys and master carriers as shown in figure 7 for a one-way draw.
7. Attach wood or metal fascia to track per figure 8 or figure 9, respectively.

FINIAL ATTACHMENT – See figure 13.

PIN SETTING – See figure 14.

MOUNTING BRACKETS/SUPPORTS

For longer rods, install two brackets 24" apart at each drapery-stacking end of rod. Additional brackets should be spaced at 48" intervals for drapery weighing 2 pounds per foot or less and at 36" intervals for drapery weighing more than 2 pounds per foot. Maximum weight is 3-1/2 pounds per foot.

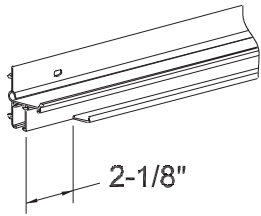

Figure 1



Figure 2

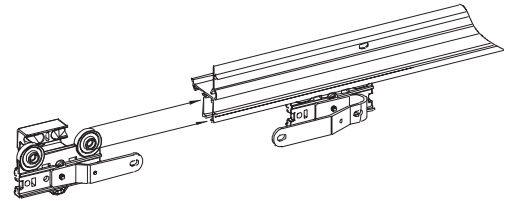

Figure 3

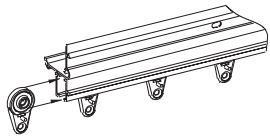

Figure 4

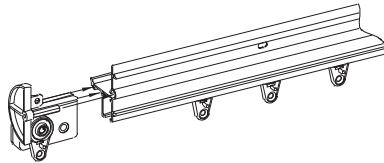

Figure 5

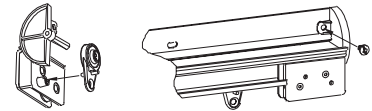

Figure 6

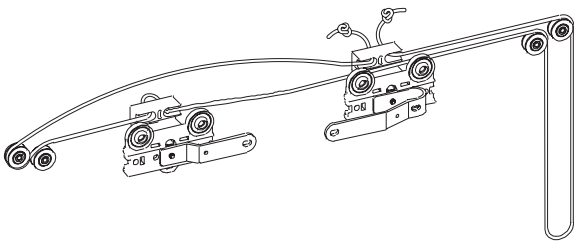

Figure 7

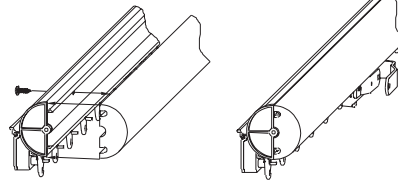

Figure 8

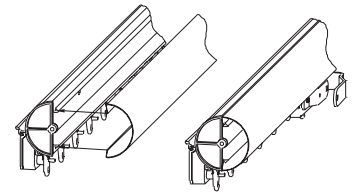

Figure 9

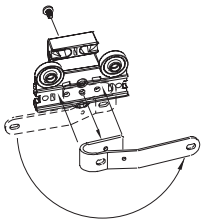

Figure 10

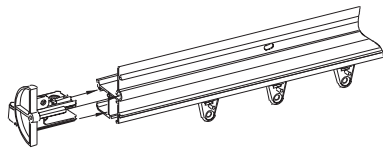

Figure 11

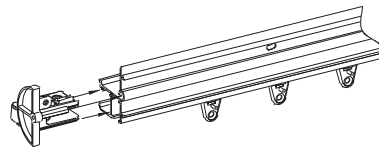

Figure 12

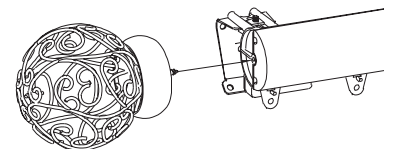

Figure 13

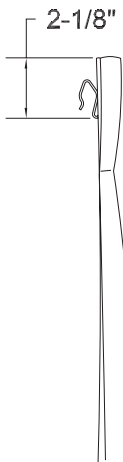

Figure 14

